

Installation

Note: This template may have expanded or shrunk slightly. Please confirm dimensions before use.

How to install the Remote Control Unit

- Using the mounting template, open a mounting hole in the installation site.
- Set the flush mount gasket and unit to the hole.
- Fix the unit with four flush mount screws (Ø3x13), then attach the front panel.
- Connect the USB connector of the unit to the USB port.

If it is necessary to remove the front panel after the unit is installed, insert a slotted head screwdriver into the slot on the unit, then turn the screwdriver.

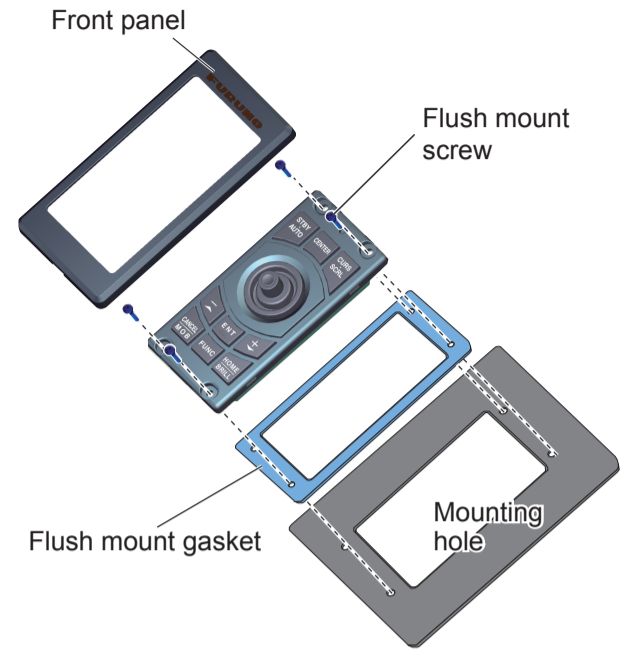

Outline and dimensions

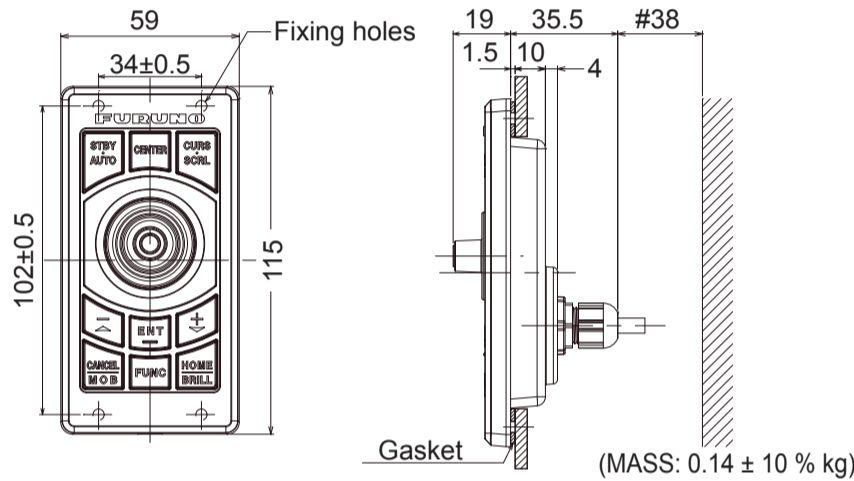

Packing List

Name	Type	Qty
Remote Control Unit	MCU-002	1
Front Panel	FRC-D01-003	1
Flush Mount Gasket	FRC-D01-008	1
Flush Mount Screw	SUS304 BH T/S-1	4

Note:

- Table 1 indicates tolerance of dimensions which is not specified.
- #: Minimum service clearance.

Table 1

DIMENSIONS (mm)	TOLERANCE (mm)
0 < L ≤ 50	±1.5
50 < L ≤ 100	±2.5
100 < L ≤ 500	±3

Note: The instructions and screenshots on this guide are mainly based the TZT9/TZT14/TZTBB.

Controls

Control description

Tips and Notice

In the cursor mode of the MCU-002, the cross cursor is easier to use than the arrow cursor. To use the cross cursor, set [Cross Cursor] to [ON] in the [General] menu.

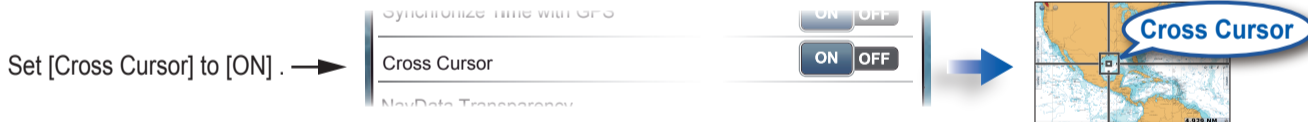

You can not set the guard zone with the MCU-002. Use the touch operation to set the guard zone.



1 STBY•AUTO key

Switches the steering mode of the FURUNO NAVpilot-700 series Autopilot between the STBY and AUTO modes.

2 CENTER key

- Returns your ship to the center of the screen (Plotter/Weather/Radar display).
- Cancels the echo history (Fish finder display).

3 CURS•SCRL key

Switches the joystick gesture between the cursor mode and scroll mode.

4 Joystick

Short push: Works same as the tap gesture.
 · Opens the pop-up menu.
 · Activates the item selected by the cursor.

Long push: Works same as the long press gesture.
 · Opens the detail pop-up menu.

Operate the joystick:

- Cursor mode operation
 - Moves the cursor.
- Scroll mode operation
 - Pans the display (Plotter/Weather/Radar display).
 - Shifts the range and scrolls back the picture (Fish finder display).

5 +, - key

Selects an item from the RotoKey™/main/pop-up menu and dialog box.

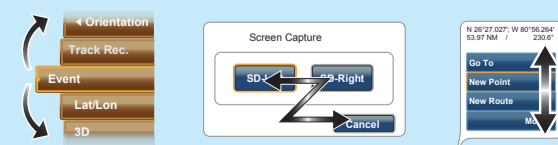

· Zooms in (+) and out (-).

6 ENT key

- Activates a selected item.
- Opens the RotoKey™ menu (TZT9/TZT14/TZTBB).
- Press the ENT key and operate the joystick to activate the Edge Swipe function (TZTL12F/TZTL15F)*: Quick page, Slide-out menu, [Layers] menu, and Data area.

- Opens the [Layers] menu.
- Opens the Quick page.

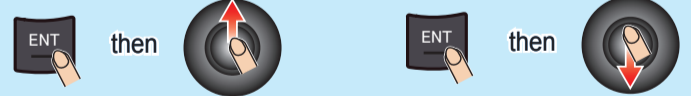

- Opens the Slide-out menu.
- Opens the Data area.

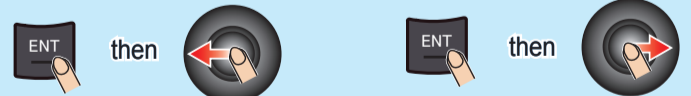

*: Requires software version 3.01 or higher.

7 CANCEL/MOB key

Short press:

- Closes the menu or dialog box.
- Stops the audio alarm.
- Ends the tool mode (End Route, End Move, etc.).

Long press:

- Enters the MOB mark at the own ship's position.

8 FUNC key

Activates the function set at [Function Gesture] menu.

9 HOME/BRILL key

Short press:

- Opens the home screen.

Long press:

- Opens the Brilliance/Power window.

How to operate the menus

Main menu operation

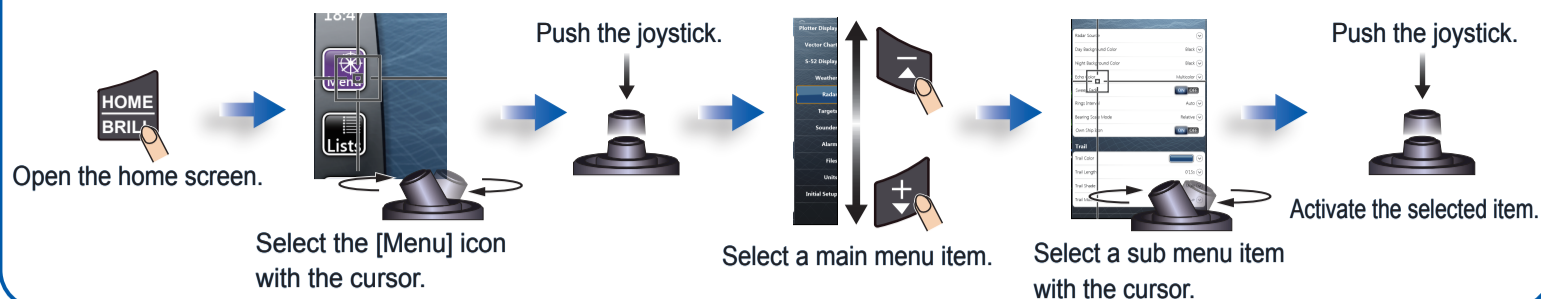

RotoKey™ menu operation



Pop-up menu operation

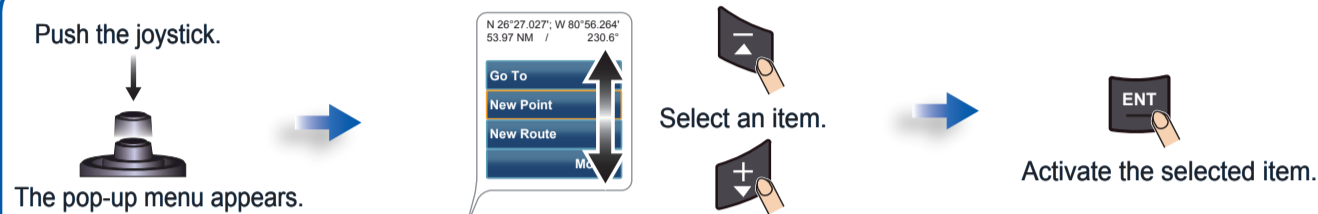

Display selection

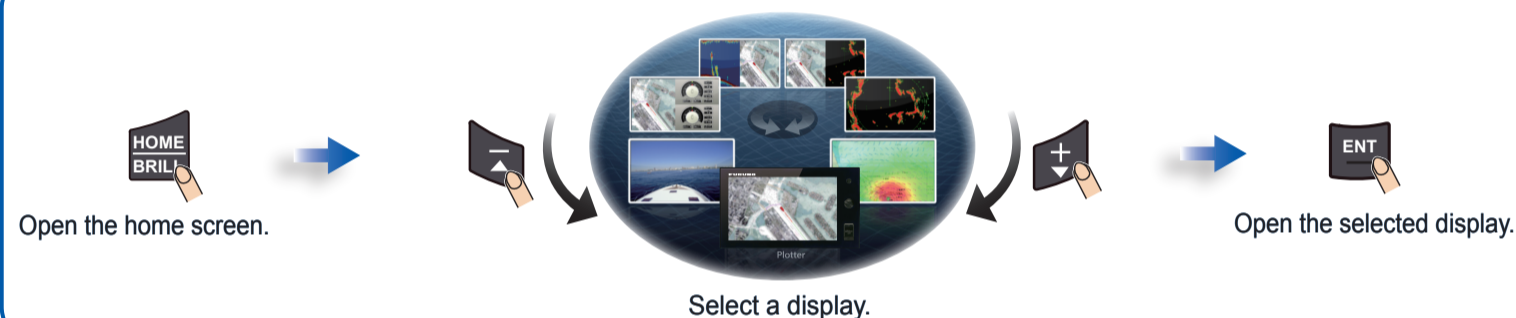

Basic operation

Zoom in and out

The +, - keys zoom in or out the chart scale (Plotter/Weather display) and select the range (Radar/Fish finder display).

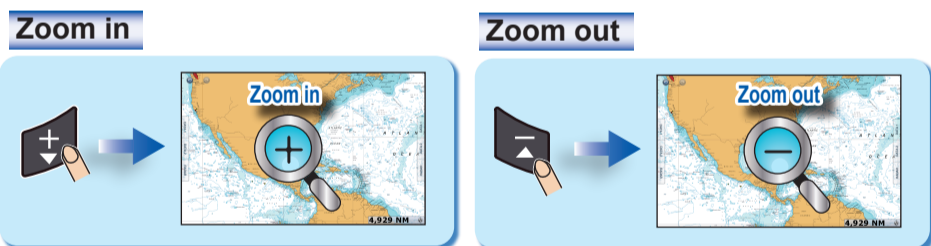

Scroll mode operation

You can pan the display (Plotter/Weather/Radar display), shift the range and scroll back the picture (Fish finder display) with the joystick. To switch to the scroll mode, press the **CURS•SCRL** key. In the scroll mode, the cursor disappears.

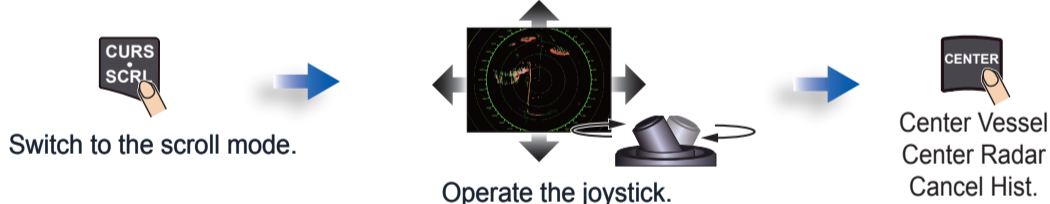

Note: In the cursor mode, you can pan the display by moving the cursor to the edge of the screen. This function is available in the full screen Plotter/Weather/Radar display.

How to put a point, How to go to a point

How to put a point

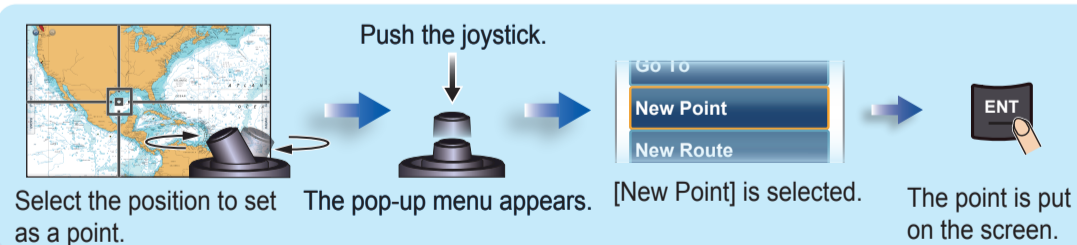

How to go to a point

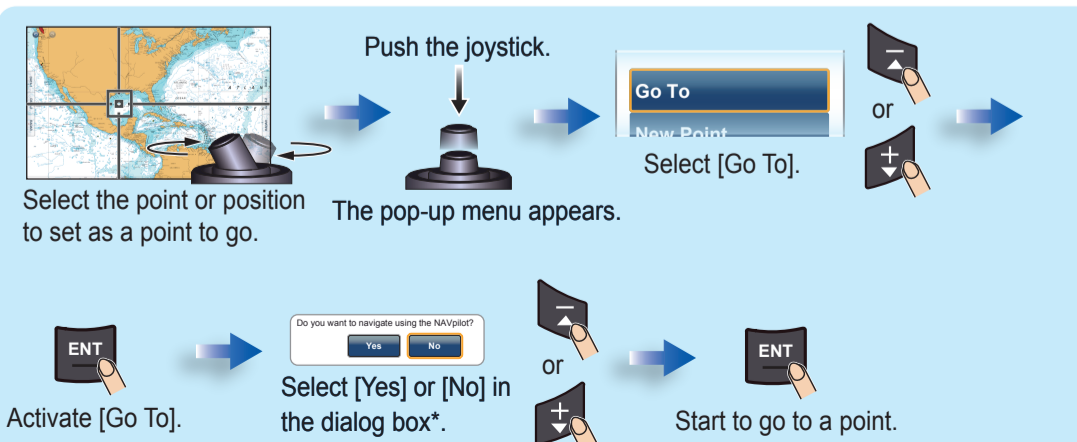

How to put an event mark

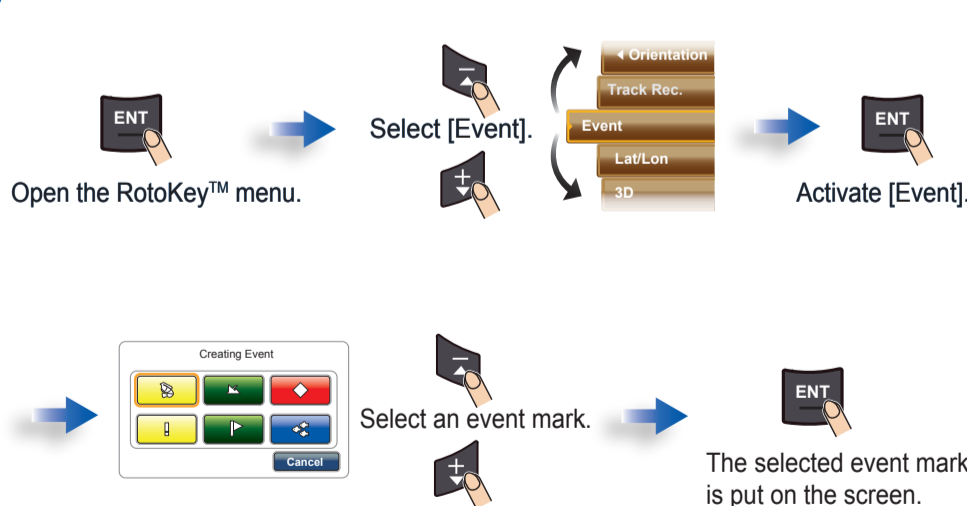

*: Appears when the NAVpilot-700 series Autopilot is installed in the TZT network.

